

Wifi gas detector user manual



APP Official Website download



APP Google Play download



Configuration QR code

1. Instruction

This gas detector used for the natural gas field, which can do the security detecting and alarming for the burning, exploding, poisoning caused by natural gas leaking. And the device has the high sensitive, stable, full type gas detecting and small size features.

2. Features

When the device detected the thickness of the natural gas get to 8% LEL, device will alarm and push the message by app, and close the electrical Valves, when the gas thickness recovery to 0% LEL, device will stop alarming and recovery to normal monitoring.

3. Technical Parameters.

Input voltage: DC5V (micro USB standard connector)
Operating current: <150mA
Alarming time: <30 second
Element age: 3 year
Installation method: wall mount
Air Pressure: 86 ~ 106Kpa
Operation Temperature: 0~55°C
Relative humidity: <80% (no condense)

4. product structure

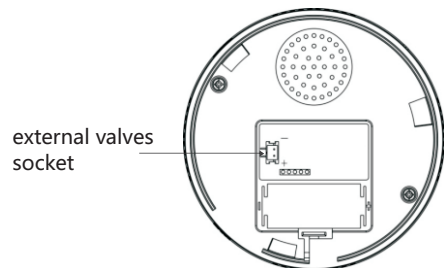
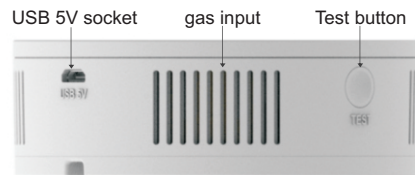

5. LCD interface introduction

(Preheat mode)

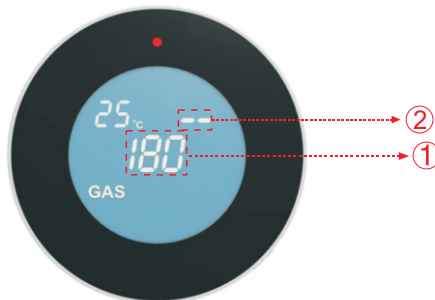

(Normal operation mode)

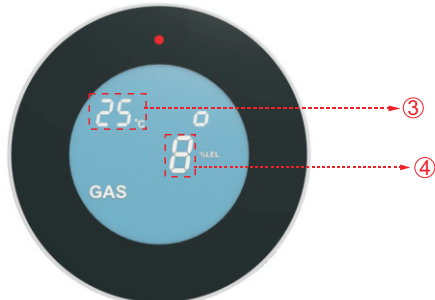

① : System preheat countdown: device need to preheat 180 seconds after power on, system will get into monitor status when preheat finished.

② : wifi mode icon: "--" flashing, means no wifi or wifi drop off "☐" means wifi connected, no wifi device, will not show this icon.

③ : current temperature value.

④ : Natural gas perimeter environment thickness value: value higher, means the thickness higher, when the thickness get to 8%LE, alarm will be triggered.

6. Testing function:

At the normal standby status, push the "TEST" button: Screen waking up, Led flashing 1 times; And voice prompts whether the device is normal.

7. Alarm function:

When device triggered, (when detector detected the gas thickness get to the warning value, then will have alarm demand) will make the alarm actions ; Device make the alarm sound, electrical valves shut. In the wifi connected mode, push the message to APP, app pushed in the back stage.

8. Mute function:

In the gas alarm status, press the "TEST" button on the device, device will get into the mute mode temporarily. Devices with WiFi function can click the mute button on the APP to temporarily silence the alarm when the network is successfully connected

9. Wi-Fi function:

Configuration used to connect the device with the wifi, after succeed, it can used the mobile app to monitor the device status remotely; mobile app is "Smart life" : ↓ Scan the QR code on the homepage of the user manual and download the app.

"Smart Life APP" has been released to the major global application stores, you can download it by searching "Smart Life" from the application store or by scanning the QR code below. Mainland China users can scan the Official Website Version and download it; non-Chinese mainland users just scan the Google Play Version . Both the Official Website Version and the Google Play one "Smart Life APP" are the same app, just only the download channels are different.



Official Website Version



Google Play Version

Note: Mainland China users may not be able to download the APP through the Google Play Version due to network.

↓ Confirm the phone is connected with Wi-Fi network.

↓ Open "Smart life" app and then click "+" to add device:

1. Choose scan → scan the Configuration QR code in the homepage;

2. Choose "Security & Sensors" → Find "Gas Alarm" → Click "Gas Detector (Wi-Fi)".

↓ In the normal monitor mode, Long press TEST button till voice prompts "enter wi-fi configuration mode", the led will flash quickly for 0.5s/1 times and enter into Wi-Fi Smart Mode.

↓ Click "Confirm indicator rapidly blink" → Enter Wi-Fi password correctly and click OK, APP will connect the device to the network (please do not press the TEST button during this process);

If configuration is successful: the voice of device will prompt "configuration already"; as long as the network is not changed, it is not necessary to configure the network again;

If configuration is failure: Short press "TEST" button and switch to configuration mode, the LED flashes slowly for 3s/1 times and enter into AP code;

Continue to configure the network according to the APP prompt; if the network is not successfully configured within two minutes, the device will enter the normal monitoring mode.

↓ at the preheat countdown status, press "TEST" button for 5 times, Wi-Fi status icon "--" blinking means the Wi-Fi unbind succeed. (Remark: after Wi-Fi unbinding, device will drop off the network, need to configure it again and then use the app.)

10. Electrical Valves output function:

Natural gas alarm status: gas alarm happened, the valves will output.

Testing mode: at the standby mode, press the "TEST" for 4 times and loose, the valves will output.

11. Device adjusting:

↓ plug the power at the USB 5V socket of the device.

↓ after power on, device get into the 180s preheat countdown.

↓ after the countdown finished, device get into the normal monitor status,

↓ press "TEST" button for function testing

↓ After completing the above steps, the alarm can monitor the environment normally.

12. Installation& usage instruction

→ Installation attention :

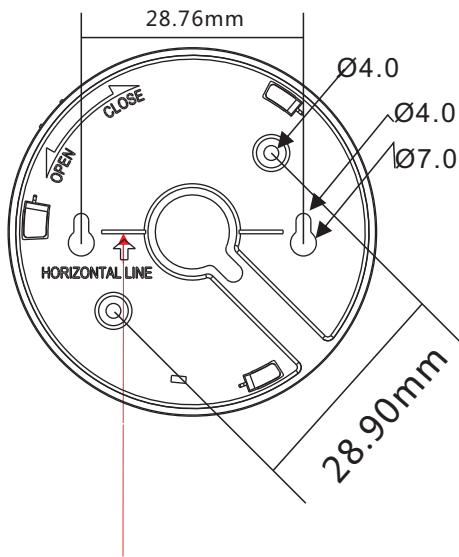

- a. Device designed for wall mount, please install the device on the upright direction for the gas leaking happened areas.
- b. device cannot install at the upper direction near the gas source, should be 2m higher than the gas source(to avoid the mistaking alarm while use the gas normally).
- c. device cannot install the bathroom or the humid place.
- d. device cannot near the paint oil and alcohol, place have these kind of products, need to remove to avoid destroy the sensors.

→ Install dimension :

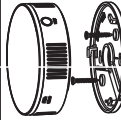

To ensure the best viewing angle of LCD display, the horizontal line as the standard, place and install the mounting plate horizontally

> Fixing:

Installing with screws	<ol style="list-style-type: none"> a. drilling holes on the ceiling with impact; b. Install the expansion tube on the ceiling; c. Fix the mounting plate with tapping screws; d. Align the detector with installation plate' s alignment and close it, then turn clockwise, and then you will hear the "click" It means the detector is installed in place. 	
Installing with double-sided adhesive	<ol style="list-style-type: none"> a. Remove the the protective film on t one side of double-sided adhesive, and then stick the double-sided adhesive onto the back of mounting plate b. Remove the protective film on the other side of the double-sided adhesive, and then fix the mounting plate onto the ceiling; c. Align the detector with installation plate' s alignment and close it, then turn clockwise, and then you will hear the "click" It means the detector is installed in place. 	

13.Emergency Response

When the gas concentration value reaches 8% LEL, the detector will make sound alarm and send alarm information to center. It indicates there is high concentration of leaked gas in the environment. The discoverer should immediately check according to the following procedure.

Note: Leak of paint, cosmetics, alcohol and other chemical products may also trigger alarm, please keep them away from the sensor to avoid false alarm

1. Turn off all gas sources.(stoves, cookers, gas water heaters, etc.)
2. Immediately open the doors and windows to make air flow.
3. Do not turn on other electrical appliances.
4. If someone feels headache, nausea, general weakness, irritability or shock and other symptoms, should be rushed to the hospital for emergency treatment.
5. After the gas subsided, find the cause of the alarm and solve it.

6. If you can not rule out the cause of the accident, please consult your property management office.
7. For the cause of the detector' s quality problem, please contact the supplier for inspection.
8. For gas leakage cause, please contact the gas company to overhaul gas pipelines, water heaters or stoves, etc. Which may cause leakage of gas.

Note: Leak of paint oil, cosmetics, alcohol and other chemical products may also trigger alarm, please keep them away from the sensor to avoid false alarm.

14.Attention

This is a security device. It keeps working after power up. In use and maintenance process, if found to have the following fault symptoms, it should be promptly treated (see the following a / b / c description). If can not be resolved in time, should contact the after-sale service center in time. After the product get back to normal operation, the user should self-check gas regularly according to their own situation to ensure normal operation.

- a. Please refer to installation instructions and debugging chapters.
- b. Check and test alarm&power state once a week, contact the service provider if problem found
- c. Users are prohibited to disassemble the device , and don' t clean the device with chemical spray, it may cause damage to the sensor. Please contact professional company or service provider for cleaning.

15.Remarks

1. It is recommended to install with screws. If install with double-sided adhesive and cause accident and security incidents, the user should bear their own responsibility
2. The alarm shows the concentration value only as a reference value of the gas detector, not as accurate concentration value.
3. The alarm shows the concentration value only as the temperature inside the alarm; due to the high internal temperature of the alarm, it may be different from the room temperature.